



NORDcanopy HC Ventilation Ceiling

Modular design

AirGrip system

Laser welded structure

Efficient HFK grease filters protected by utility patent

Energy efficient LED lights

HC Ventilation Ceiling

4



Modules Available

HCE
Exhaust Wall Module

5



HCI
Exhaust V-module

7



HCG
AirGrip Module

9



HCH
Horizontal Supply Air Module

12



HCV
Vertical Supply Air Module

14



HCAH
Horizontal Supply Module

18



HCL
LED Light Module

21



HCF
Ceiling Panel

23

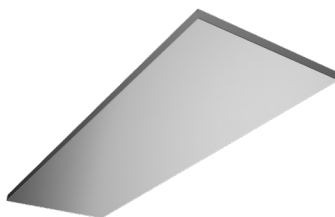

HCM
Noise Absorbing Ceiling Panel

24



Exhaust and Supply Corner Elements

HCAE
Inner Corner Exhaust

25

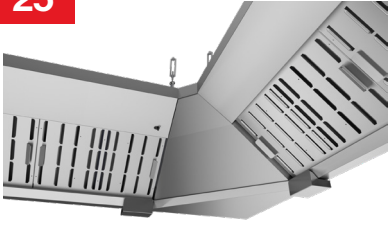

HCAS
Inner Corner Supply

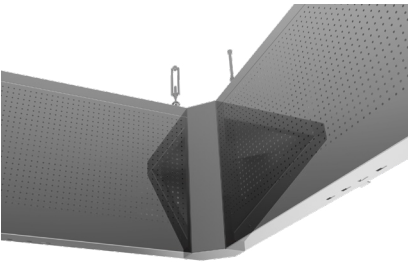

HCAV
Outer Corner Supply

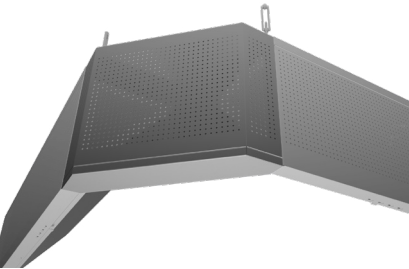

HC Options & Accessories

OZ
Ozone Unit

26



EOZ
Ozone Generator



HFK
Grease Filter

29

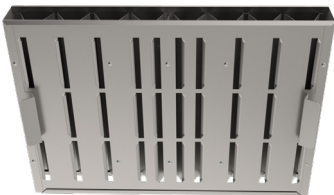

FET "Helping hand"
Grease filter removal tool

30



HC Ventilation Ceiling

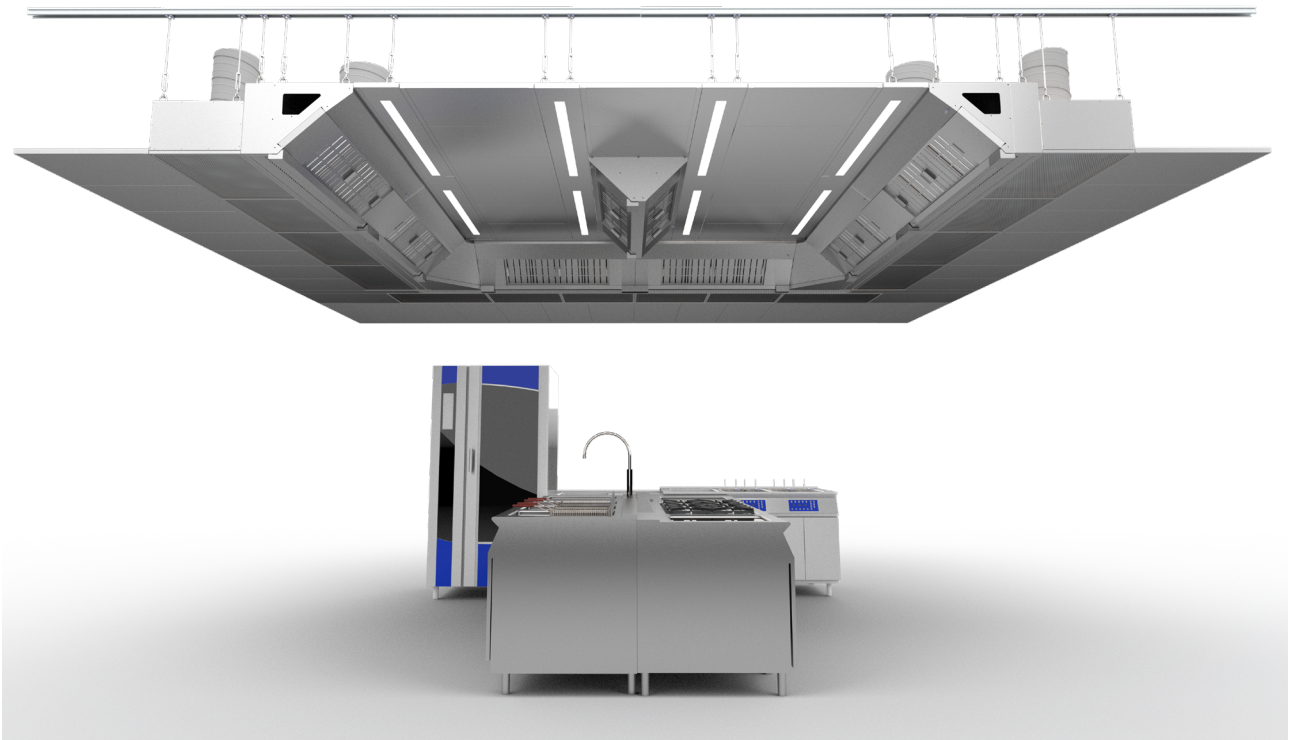

ETS NORD's ventilation ceiling system combines effective grease removal with stylish design to thoroughly clean the exhaust airstream and remove excess heat from the kitchen. We at ETS NORD know that no two projects are exactly alike. Since ETS NORD kitchen ventilation solutions are modular in their construction, each ventilation ceiling can be individually designed to meet every project requirement or technical need.

The food safety of ETS NORD's canopies has been verified with the HACCP international certificate.

The system consists of a different broad selection of exhaust and supply modules, sound absorbing panels and LED-lighting options. In addition to mechanically separating grease with our highly efficient HFK grease filters, the ventilation ceiling can also include an intelligent ozone cleaning system to further reduce grease and odor. Ozone treatment is simply chemical oxidation, whereby grease and odor are broken down to water vapor and dry minerals, thereby providing many advantages.

NORDcanopy products are manufactured from stainless steel according to standards EN 10088- 2:2014, EN 1.4301 or AISI 304 (AISI 304, surface 2K).

- Duct connections are equipped with rubber gaskets.
- Supply air modules are heat insulated to prevent condensation of steam on the inner surface of the chamber.
- The laser welded end walls of the exhaust chamber prevent the possible leakage of grease from the inside of the chamber, thereby reducing the possibility of bacteria forming in the joints.
- Easy-to-clean surfaces.
- Access to the supply chamber and the ability to clean the supply ducts is ensured through the easy-to remove front panels. Exhaust ducts can be easily reached and insulated via removable ceiling panels.
- Adjustable suspension hooks are included.

HCE Exhaust Wall Module

HCE is an exhaust air module with one row of HFK grease filters for installation against walls. HCE ensures a clean, hygienic and comfortable work environment by removing pollutants, excessive heat and grease from the cooking process. HCE exhaust module has laser welded construction.

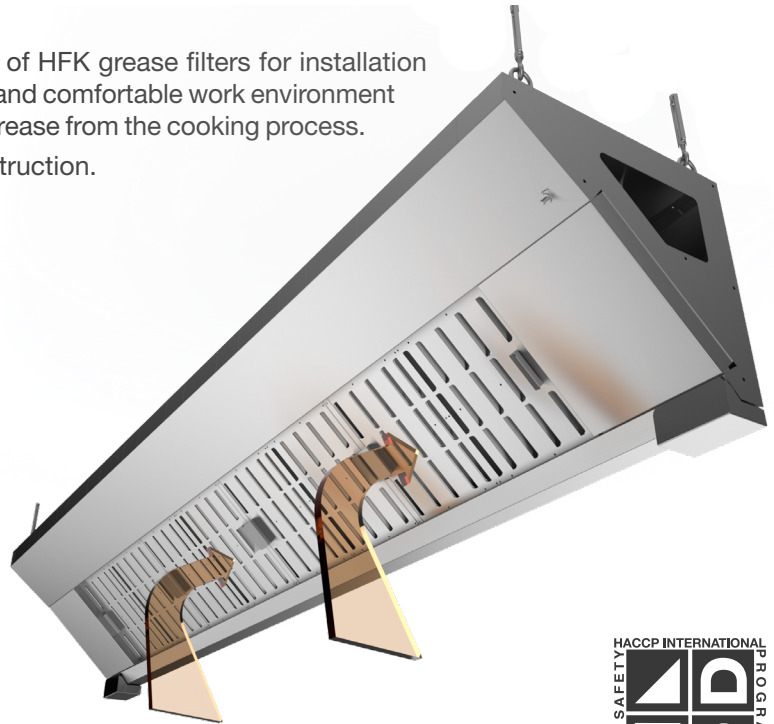

Dimensions

HCE-E1

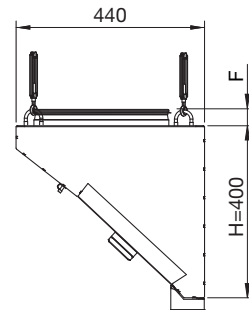

Length L	Connections		
	Ød, mm	E1 quantity n	F
1000	250	1	43
1000	315	1	43
1500	250	1	43
1500	315	1	43
2000	250	2	43
2000	315	2	43
2500	315	2	43
2500	315	3	43

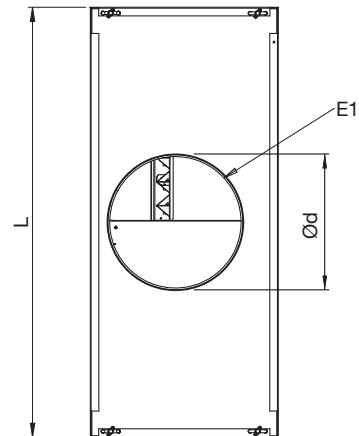

Product marking

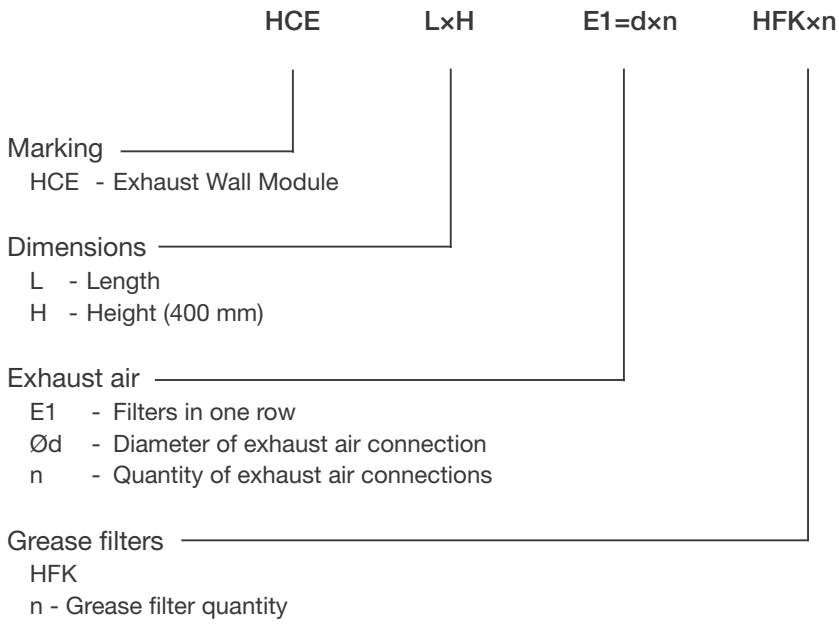

Example: HCE 1500x400 E1=250x1 HFKx3

HCI Exhaust V-module

HCI is a V-shaped exhaust air module with two rows of HFK grease filters, one on each side. HCI grease module ensures a clean, hygienic and comfortable work environment by removing pollutants, excessive heat and grease from the cooking process.

HCI exhaust module has laser welded construction.

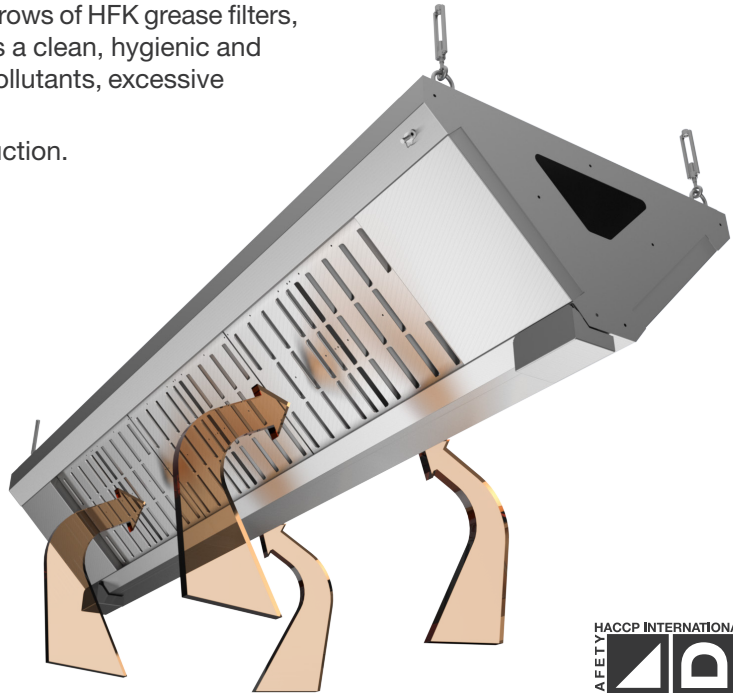

Dimensions

HCI-E3

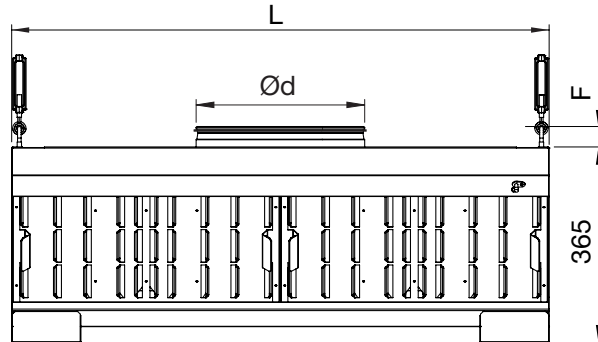
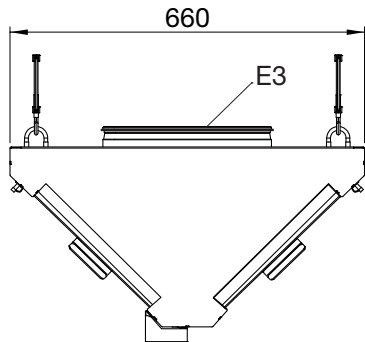

Length L	Connections		
	Ød, mm	Quantity, n	F
1000	315	1	43
1000	400	1	55
1500	315	2	43
1500	400	1	55
2000	315	2	43
2000	400	2	55
2500	315	3	43
2500	400	2	55



Technical data

HFK - grease filter

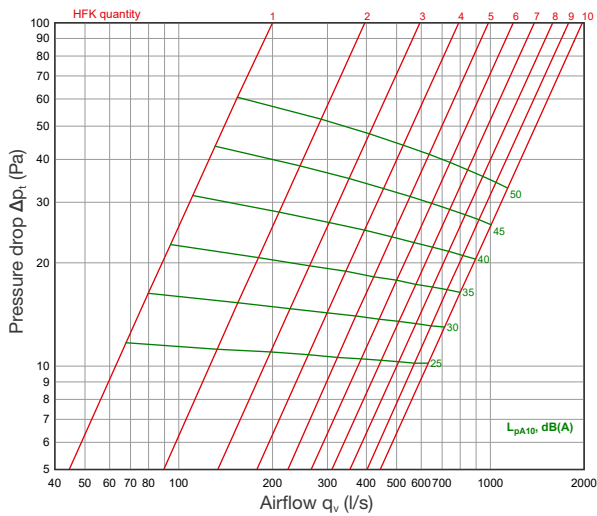

Sound attenuation of HFK

$L_{w\text{okt}} = L_{pA} + K_{\text{okt}}$

HFK	Sound level correction factor K_{okt} (dB)							
	Mean frequency of octave band (Hz)							
	63	125	250	500	1000	2000	4000	8000
K	4	3	0	1	0	-4	-15	-21

Product marking

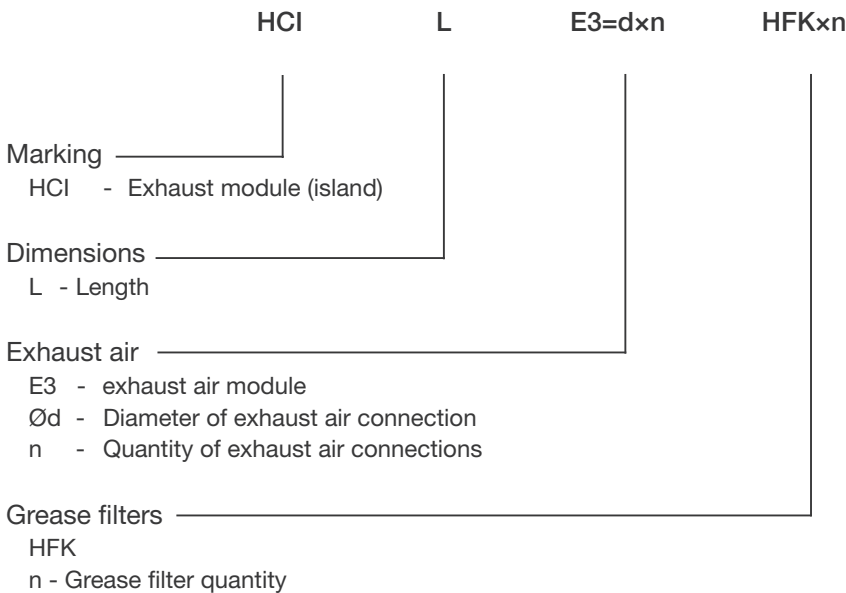

Example: HCI 1500 E3=315x2 HFKx6

HCG AirGrip Module

HCG AirGrip module uses capillary action to capture and direct kitchen emissions toward the exhaust modules, much like that of an air curtain. With both vertical and horizontal airflow components, HCG significantly improves ventilation ceiling effectiveness.

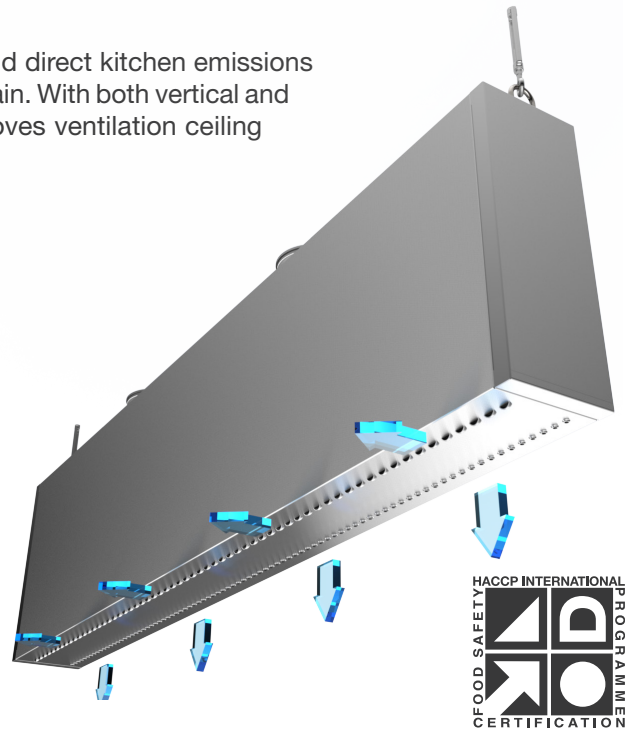

Dimensions

Length L	Connections quantity
1000-1500	1
1600-2000	2
2100-3000	3

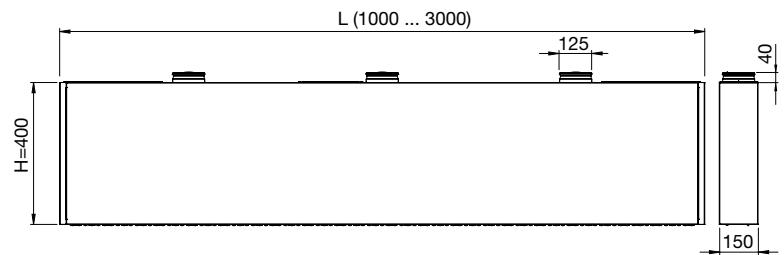

Technical data

Air adjustment plate position open or closed.

HCG L=1000

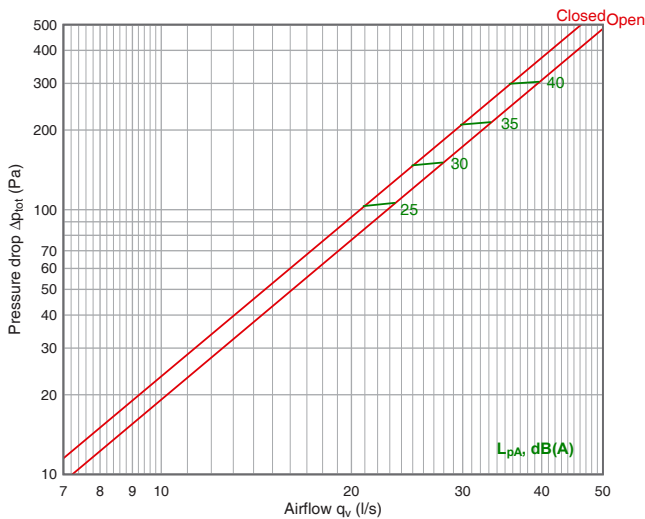

HCG L=1500

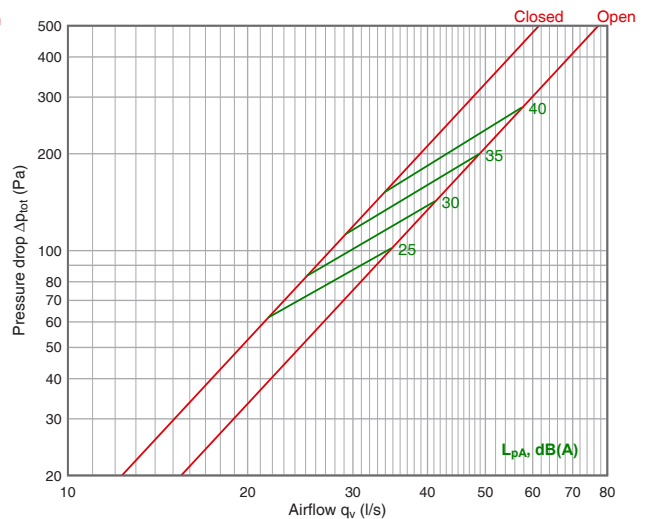

HCG L=2000

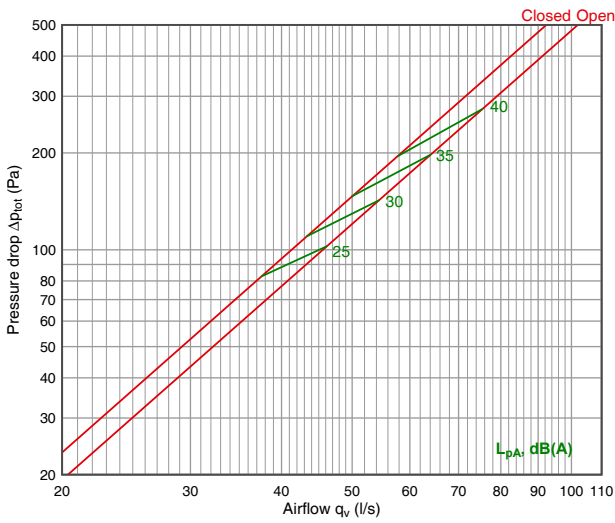

HCG L=2500

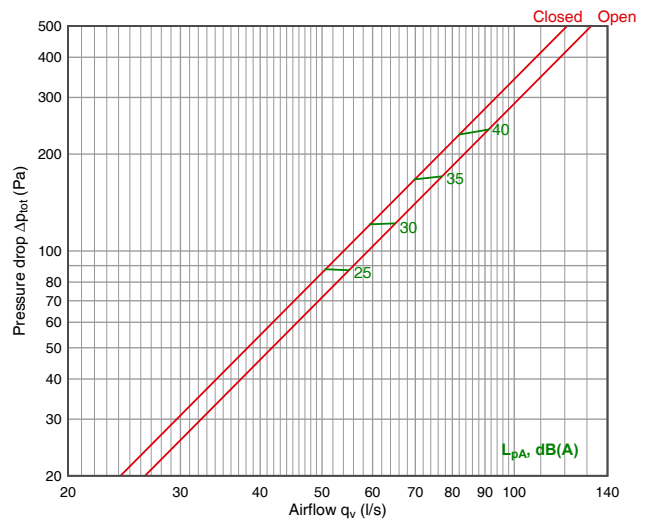

HCG L=3000

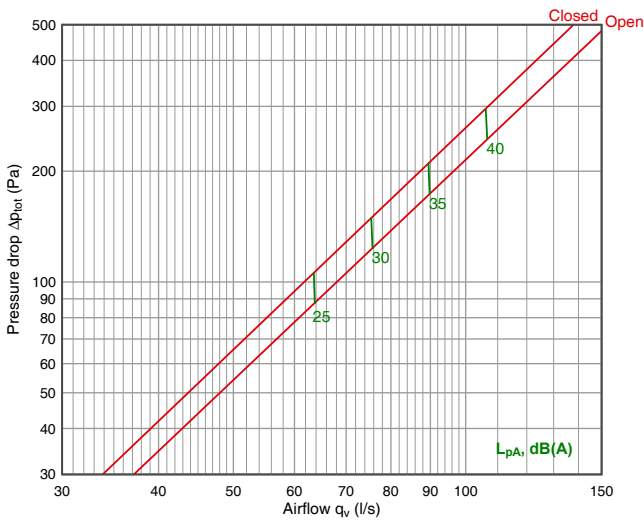

Acoustic data

Supply air	Air adjustment plate	K-factor	Correction of sound level K_{okt} [dB] (Hz)							
			63	125	250	500	1000	2000	4000	8000
HCG 1000	Closed	2,34	0	-2	-1	-5	-4	-7	-12	-14
	Open	2,33	-3	-6	-6	-7	-6	-5	-8	-11
HCG 1100	Closed	2,57	0	-2	-1	-5	-4	-7	-12	-14
	Open	2,56	-3	-6	-6	-7	-6	-5	-8	-11
HCG 1200	Closed	2,81	0	-2	-1	-5	-4	-7	-12	-14
	Open	2,80	-3	-6	-6	-7	-6	-5	-8	-11
HCG 1300	Closed	3,04	0	-2	-1	-5	-4	-7	-12	-14
	Open	3,03	-3	-6	-5	-7	-6	-6	-9	-12
HCG 1400	Closed	3,28	0	-2	-1	-5	-4	-7	-12	-14
	Open	3,26	-3	-6	-5	-7	-6	-6	-9	-12
HCG 1500	Closed	3,45	0	-2	-1	-5	-4	-7	-12	-14
	Open	3,45	-3	-6	-5	-7	-6	-6	-9	-12
HCG 1600	Closed	3,74	-2	0	2	-1	-6	-13	-17	-21
	Open	3,73	-2	-6	-3	-6	-6	-7	-10	-13

Supply air	Air adjustment plate	K-factor	Correction of sound level K_{okt} [dB] (Hz)							
			63	125	250	500	1000	2000	4000	8000
HCG 1700	Closed	3,98	-2	0	2	-1	-6	-13	-17	-21
	Open	3,96	-2	-6	-3	-6	-6	-7	-10	-13
HCG 1800	Closed	4,21	-2	0	2	-1	-6	-13	-17	-21
	Open	4,19	-2	-6	-4	-6	-6	-6	-9	-12
HCG 1900	Closed	4,45	-2	0	2	-1	-6	-13	-17	-21
	Open	4,43	-2	-6	-4	-6	-6	-6	-9	-12
HCG 2000	Closed	4,67	-2	0	2	-1	-6	-13	-17	-21
	Open	4,66	-2	-6	-4	-6	-6	-6	-9	-12
HCG 2100	Closed	4,91	-2	0	2	-1	-6	-13	-17	-21
	Open	4,89	-3	-6	-6	-7	-6	-5	-8	-11
HCG 2200	Closed	5,15	-2	0	2	-1	-6	-13	-17	-21
	Open	5,13	-3	-6	-6	-7	-6	-5	-8	-11
HCG 2300	Closed	5,38	-2	0	2	-1	-6	-13	-17	-21
	Open	5,36	-3	-6	-5	-7	-6	-6	-9	-12
HCG 2400	Closed	5,62	-2	0	2	-1	-6	-13	-17	-21
	Open	5,59	-3	-6	-5	-7	-6	-6	-9	-12
HCG 2500	Closed	5,89	-2	0	2	-1	-6	-13	-17	-21
	Open	5,89	-3	-6	-5	-7	-6	-6	-9	-12
HCG 2600	Closed	6,08	-2	0	2	-1	-6	-13	-17	-21
	Open	6,06	-3	-6	-5	-7	-6	-6	-9	-12
HCG 2700	Closed	6,32	-2	0	2	-1	-6	-13	-17	-21
	Open	6,29	-3	-6	-5	-7	-6	-6	-9	-12
HCG 2800	Closed	6,55	-2	0	2	-1	-6	-13	-17	-21
	Open	6,52	-3	-6	-4	-7	-6	-7	-10	-13
HCG 2900	Closed	6,79	-2	0	2	-1	-6	-13	-17	-21
	Open	6,76	-3	-6	-4	-7	-6	-7	-10	-13
HCG 3000	Closed	7,02	-2	0	2	-1	-6	-13	-17	-21
	Open	6,99	-3	-6	-4	-7	-6	-7	-10	-13

Product marking

HCG LxH 125xn

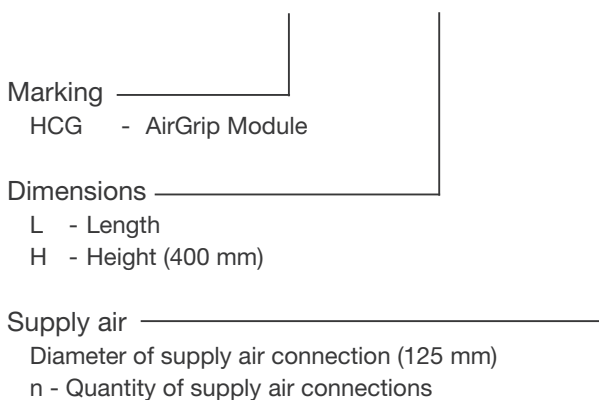

Example: HCG 1500x400 125x1

HCH Horizontal Supply Air Module

HCH is a horizontal supply air module, designed to supply fresh replacement air into the kitchen to provide ultimate worker comfort. Front panels are easily removed for accessing and cleaning its supply chambers and ducts.

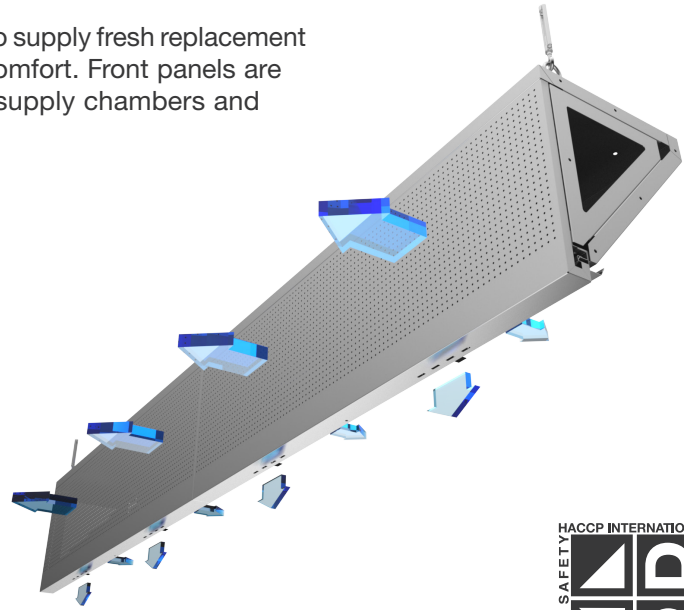

Dimensions

Length L	Connections quantity
1000	1 ... 2
1500	1 ... 2
2000	2 ... 3
2500	2 ... 3

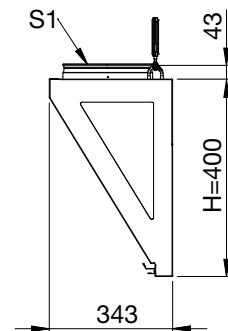
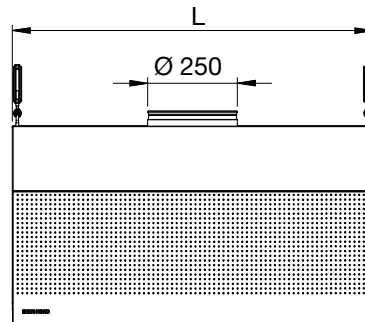

Technical data

The supply panels always contain the “AirGrip” air intake system.

Supply air: SPx1

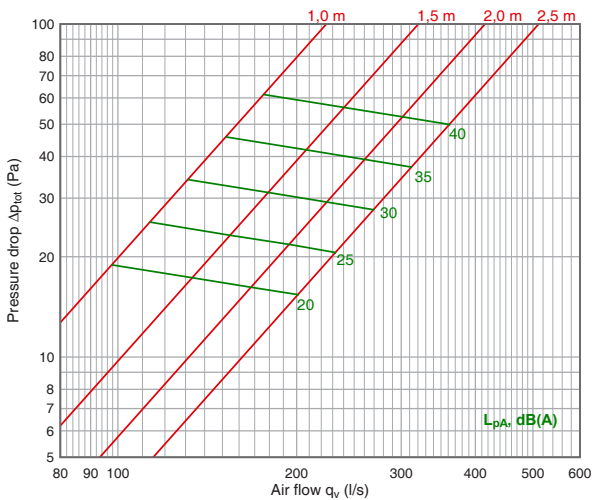

Supply air: SPx2

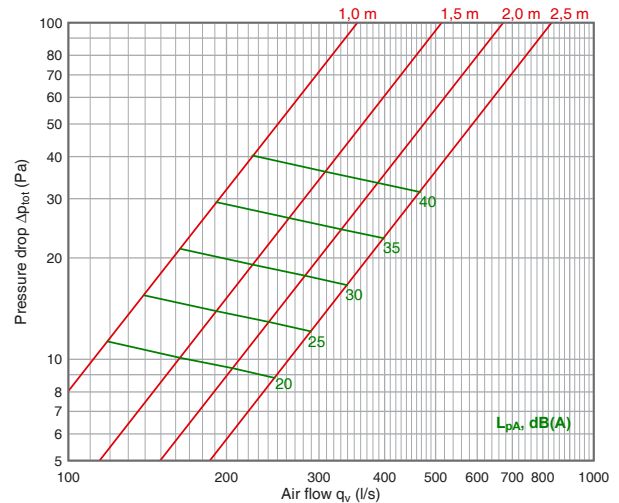

Supply air: SPx3

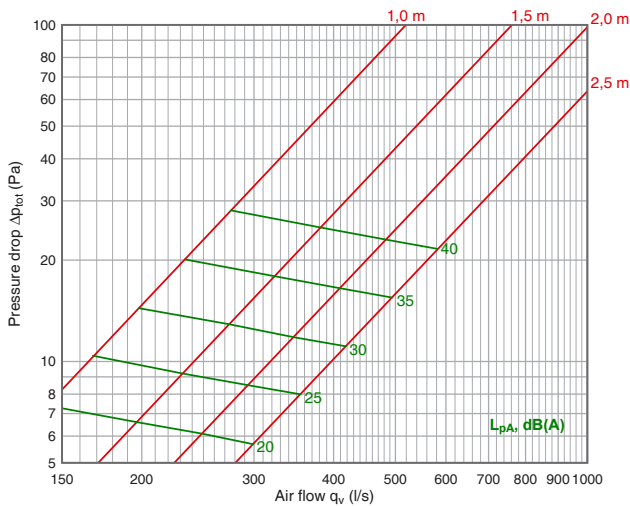

Acoustic data

$$L_w = L_{p10A} + K_{okt}$$

Supply air	Correction of sound level K_{okt} (dB)							
	(Hz)							
	63	125	250	500	1000	2000	4000	8000
SPx1	-1	0	3	2	-1	-3	-11	-23
SPx2	0	1	5	4	-1	-8	-20	-27
SPx3	7	5	6	4	-2	-13	-21	-30
	± 4 dB	± 4 dB	± 4 dB	± 2 dB	± 2 dB	± 2 dB	± 2 dB	± 2 dB

Product marking

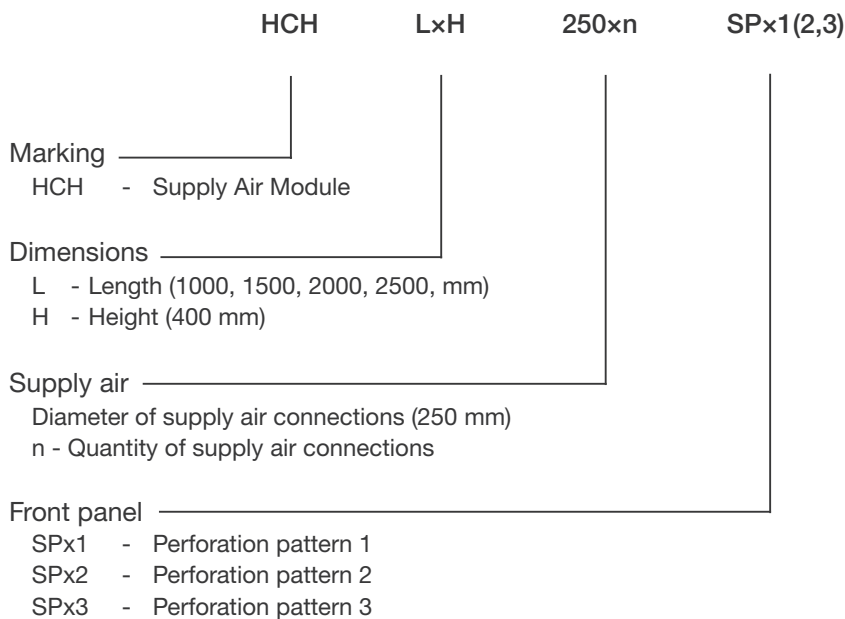

Example: HCH 1500x400 250x1 SPx1

HCV Vertical Supply Air Module

HCV is a vertical supply air module, designed to supply fresh replacement air into the kitchen area to provide ultimate worker comfort. HCV can also be used for some exhaust applications as well.

Its panels can be removed for cleaning purposes and easy access to supply ducts.

- Even and draft-free air distribution in the kitchen
- Easy to clean surfaces
- Easily removable front panels
- The frame is manufactured from 1 mm stainless steel (AISI 304, surface 2K)
- Supply air duct connections are Ø 250 mm and equipped with rubber seals and integrated dampers

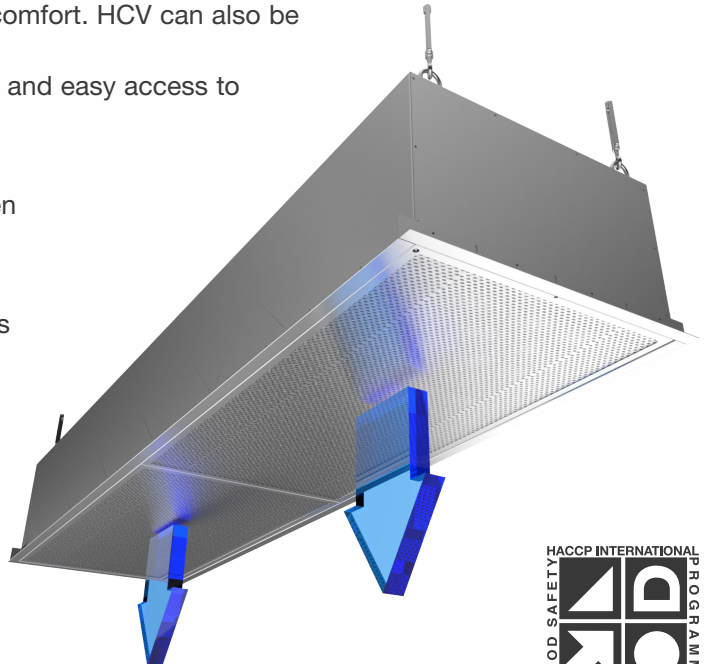

Dimensions

Length L	Connections quantity	C
1000	1	-
1500	2	750
2000	2	1000
2500	3	1500

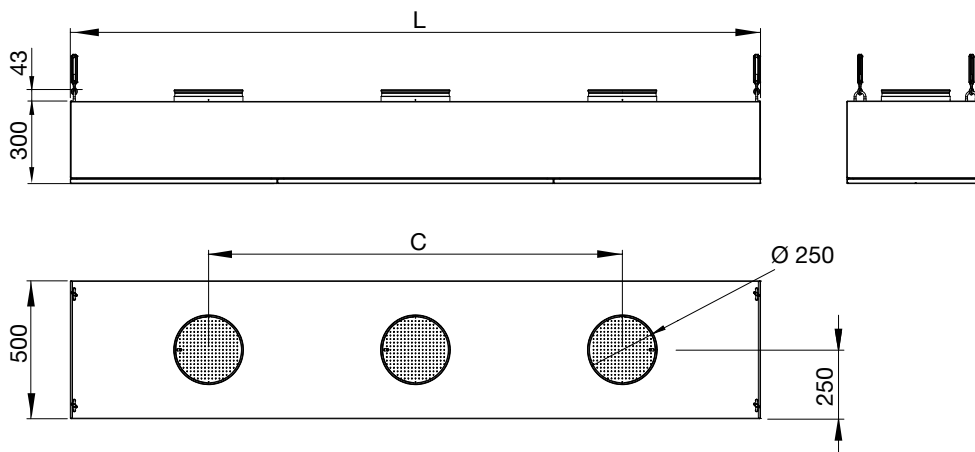

Technical data

Supply air

HCV 1000

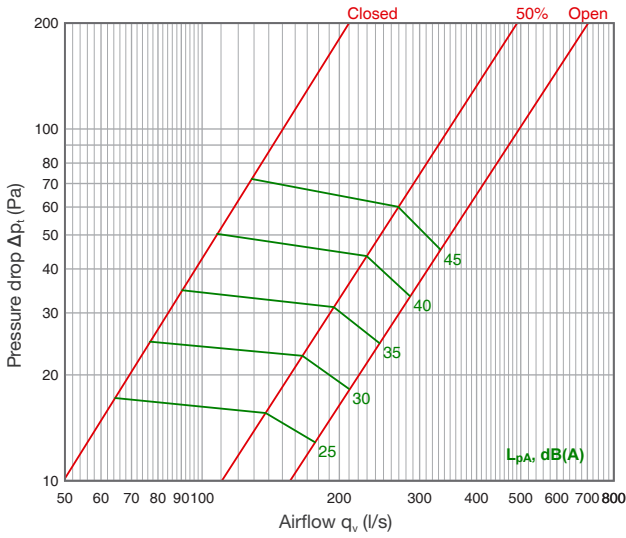

HCV 1500

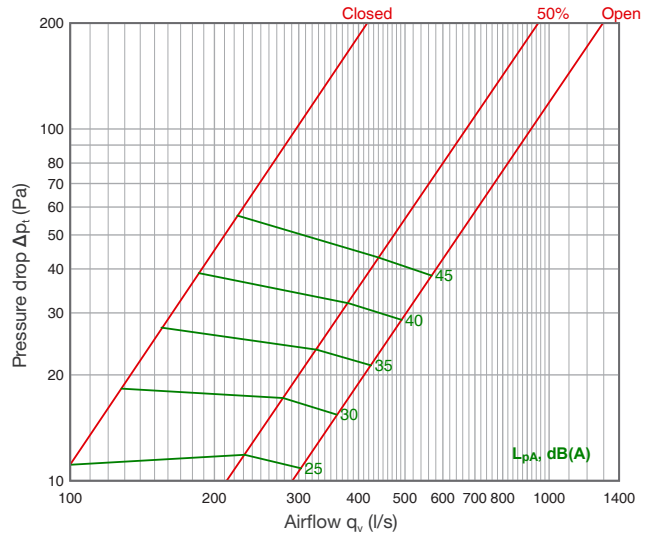

HCV 2000

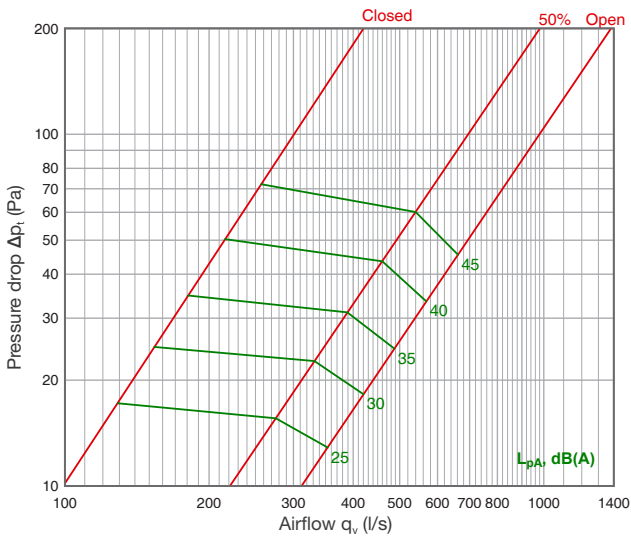

HCV 2500

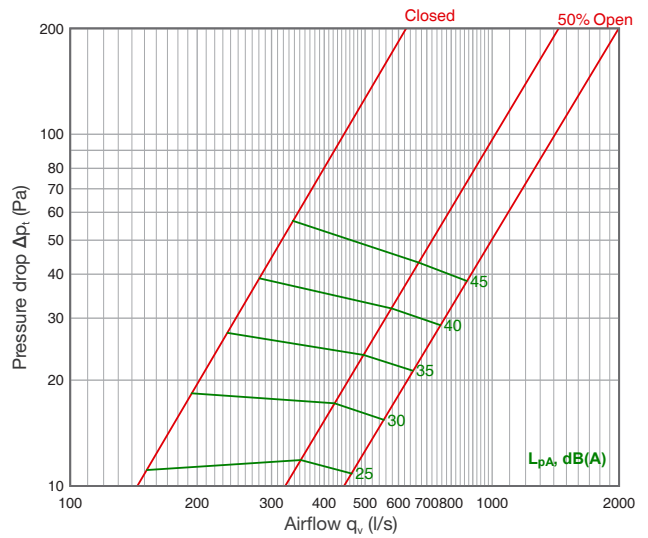

Exhaust air

HCV 1000

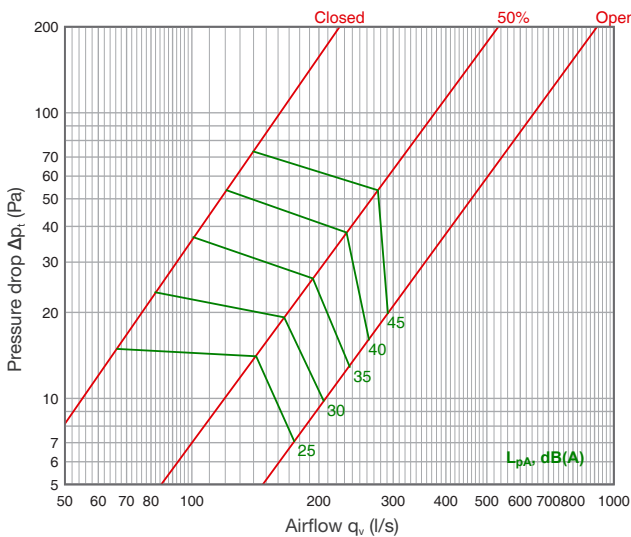

HCV 1500

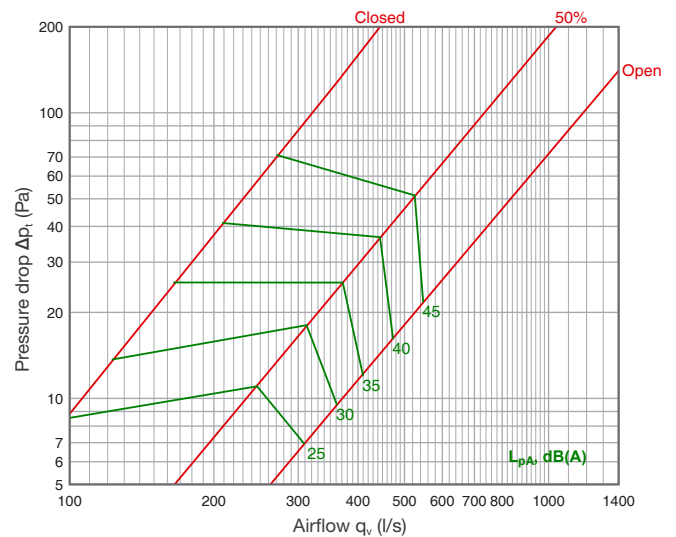

HCV 2000

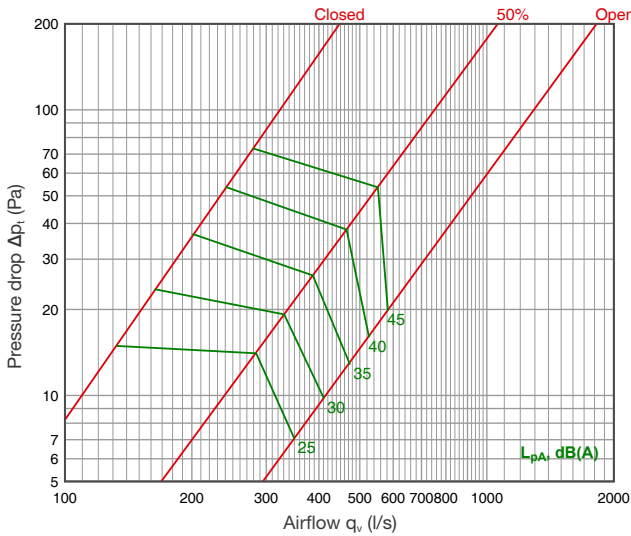

HCV 2500

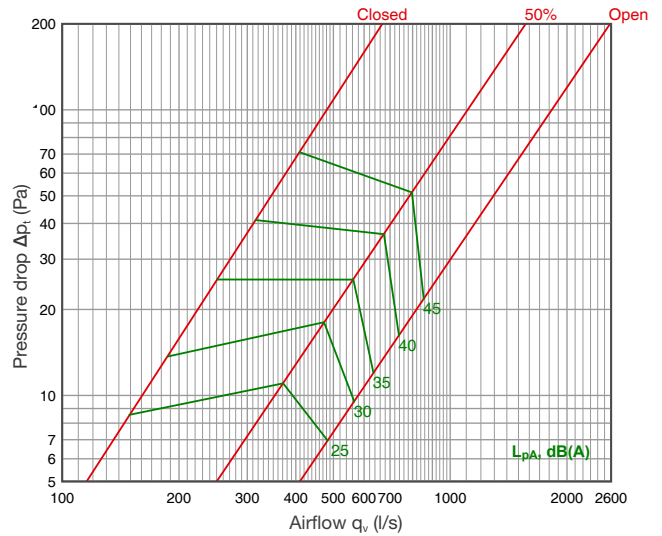

Acoustic data

Supply air, $L_w = L_{wA} + K_{okt}$

Product	Position	Sound level correction factor K_{okt} (dB)							
		Mean frequency of octave band (Hz)							
		63	125	250	500	1k	2k	4k	8k
HCV 1000	Open	-0,6	-0,9	-3,6	-6,6	-5,6	-8,5	-13,6	-15,9
	50%	-1,3	0,1	-3,0	-5,9	-6,0	-8,4	-12,6	-15,3
	Close	-11,1	-6,2	-3,8	-0,9	-8,6	-13,2	-16,6	-14,8
HCV 1500	Open	4,0	2,2	-1,3	-6,5	-6,5	-9,9	-13,6	-17,1
	50%	3,6	2,3	-1,7	-5,2	-6,4	-10,1	-12,5	-16,3
	Close	-8,3	-7,3	-4,3	-4,0	-8,4	-12,5	-16,7	-15,8
HCV 2000	Open	-12,3	3,8	-0,8	-6,4	-6,8	-10,7	-13,6	-18,2
	50%	4,4	3,8	-0,5	-4,8	-6,6	-12,3	-12,4	-17,3
	Close	-7,6	-8,4	-4,8	-7,1	-8,2	-11,7	-16,9	-17
HCV 2500	Open	-13,2	4,3	-0,2	-6,3	-6,9	-11,4	-13,6	-19,3
	50%	5,2	4,9	-0,1	-4,5	-6,8	-12,1	-12,2	-18,2
	Close	-6,7	-9,5	-5,3	-9,6	-7,9	-11,1	-17,1	-17,2

Exhaust air, $L_w = L_{wA} + K_{okt}$

Product	Position	Sound level correction factor K_{okt} (dB)							
		Mean frequency of octave band (Hz)							
		63	125	250	500	1k	2k	4k	8k
HCV 1000	Open	-11,5	-11,1	-14,2	-10,7	-5,3	-9,0	-15,1	-17,7
	50%	-4,6	-3,7	-5,7	-6,6	-6,7	-7,4	-9,3	-12,4
	Close	-11,3	-9,5	-7,7	-5,6	-8,1	-9,8	-10,7	-12,1
HCV 1500	Open	-3,9	-6,4	-10,4	-11,9	-13,2	-12,2	-15,9	-22,5
	50%	2,6	-0,3	-3,0	-6,0	-6,9	-8,9	-10,1	-13,3
	Close	-18,9	-16,1	-13	-14,3	-15,8	-16,2	-11,7	-11,1
HCV 2000	Open	0,5	-4,7	-8,4	-12,5	-14,1	-14,3	-16,2	-23,2
	50%	4,8	1,3	-1,6	-5,7	-7,2	-9,3	-11,3	-14,2
	Close	-20,4	-18,5	-15,2	-16,5	-17,2	-17,9	-12,4	-10
HCV 2500	Open	3,4	-3,4	-6,7	-12,9	-14,7	-15,1	-16,4	-24,1
	50%	6,9	3,4	-0,3	-5,3	-7,5	-9,4	-11,6	-15,1
	Close	-22,7	-19,9	-17,3	-17,6	-18,3	-18,5	-12,9	-8,9

Sound attenuation

Product	Sound attenuation D_{okt} (dB)							
	63	125	250	500	1k	2k	4k	8k
HCV 1000	11	6	3	3	1	1	1	1
HCV 1500	12	7	3	4	2	1	1	2
HCV 2000	13	8	4	4	2	1	1	2
HCV 2500	14	9	4	5	3	1	1	3

Airflow pattern

HCV 1000x500, temperature difference (50% open)

From the long side

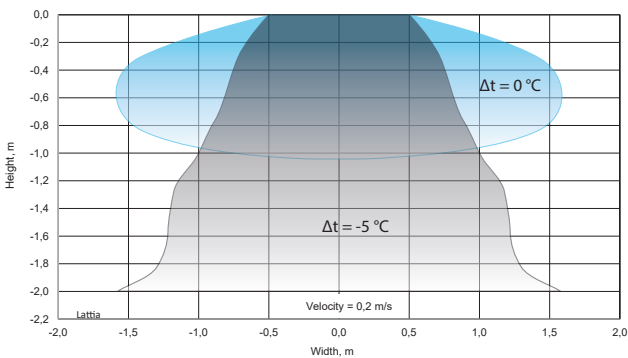

From the short side

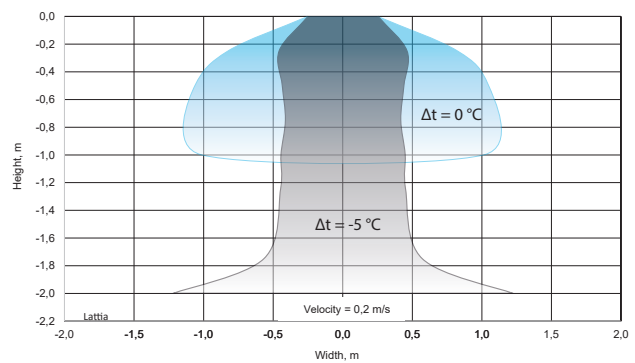

HCV 1500x500, temperature difference

From the long side

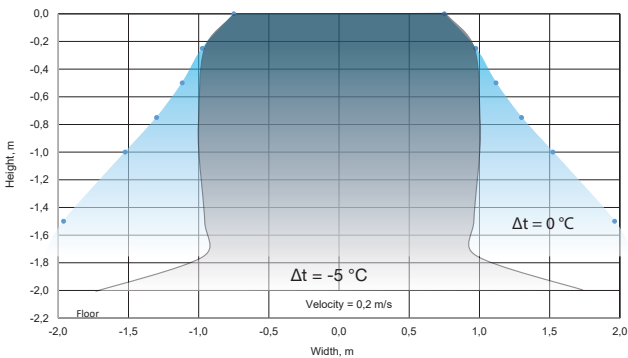

From the short side

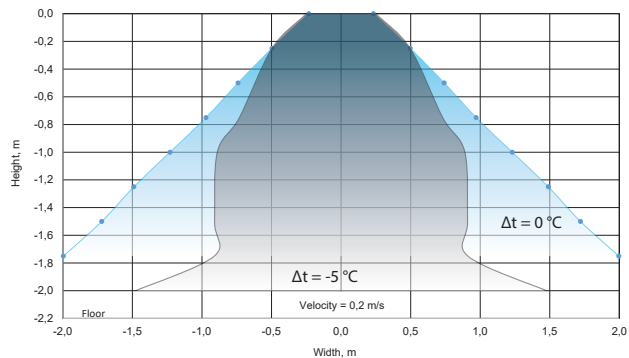

Product marking

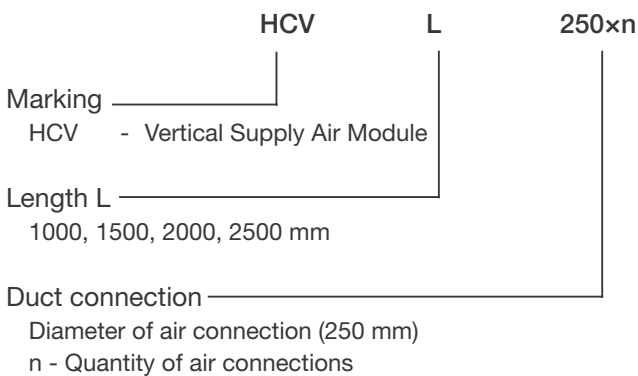

Example: HCV 1500 250x2

HCAH Horizontal Supply Module

HCAH is a horizontal supply air module including both vertical and horizontal “AirGrip” functionality. HCAH can furthermore be installed back-to-back with exhaust modules.

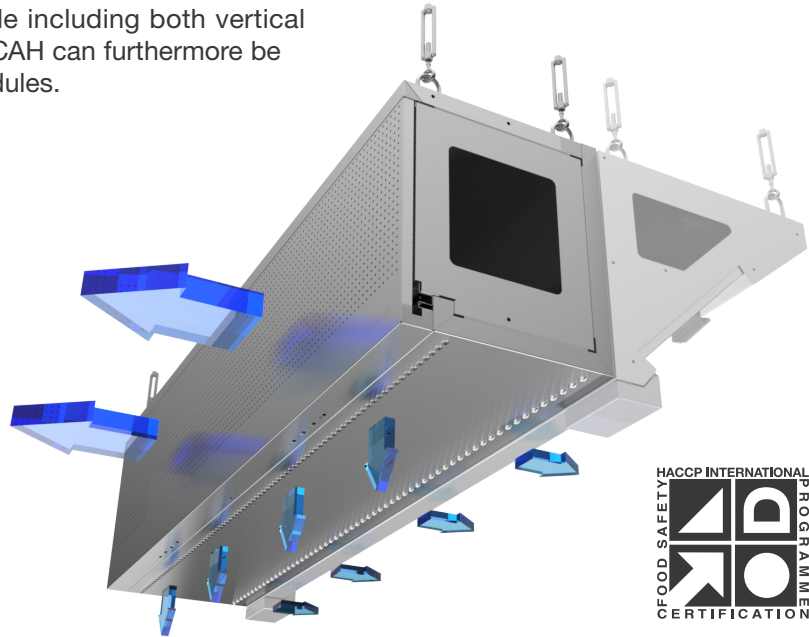

Dimensions

Length L	Connections quantity
1000	1
1500	1
2000	2
2500	2

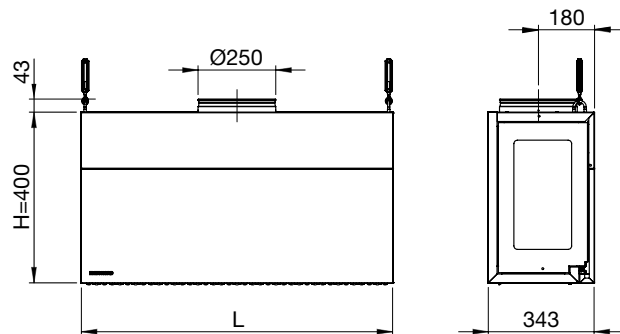

Technical data

HCAH SPx0

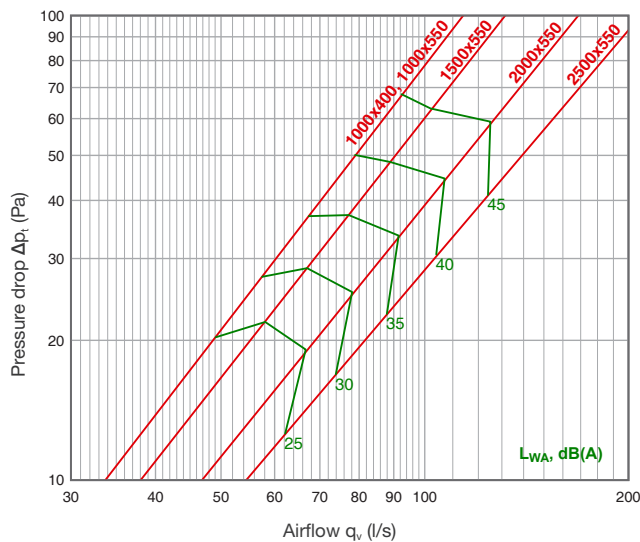

HCAH 1000x400

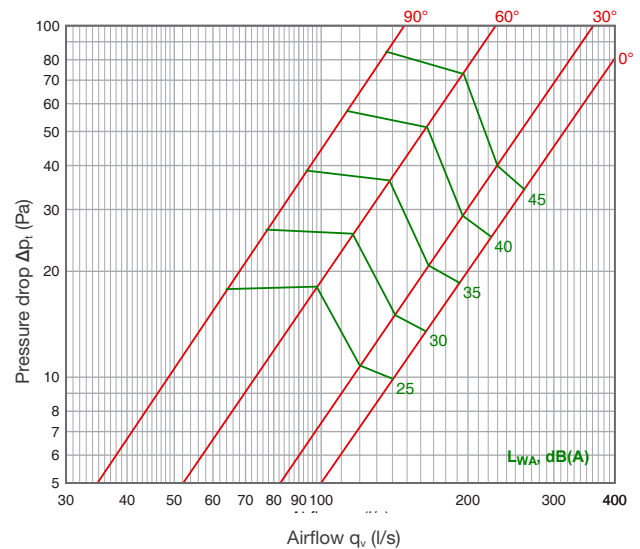

HCAH 1500x550

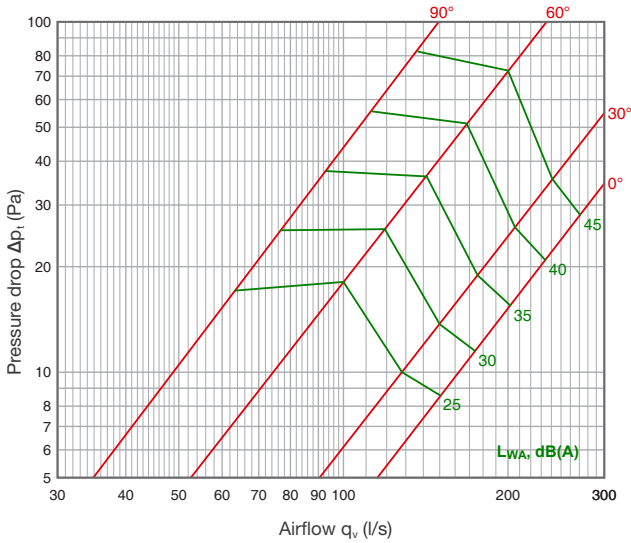

HCAH 1000x550

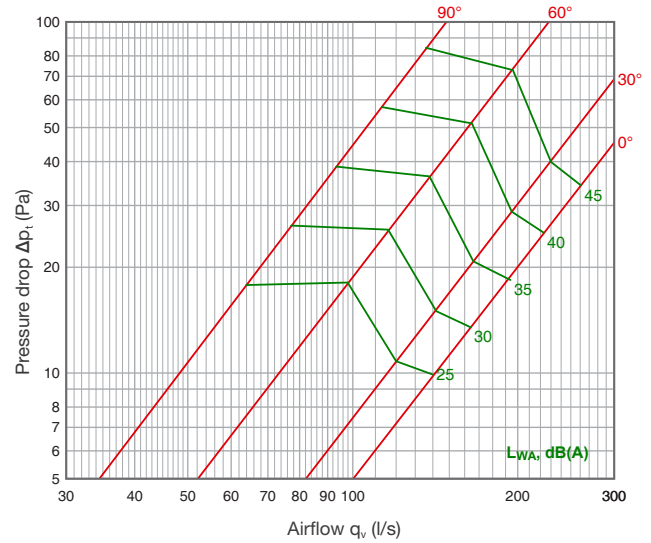

HCAH 2000x550

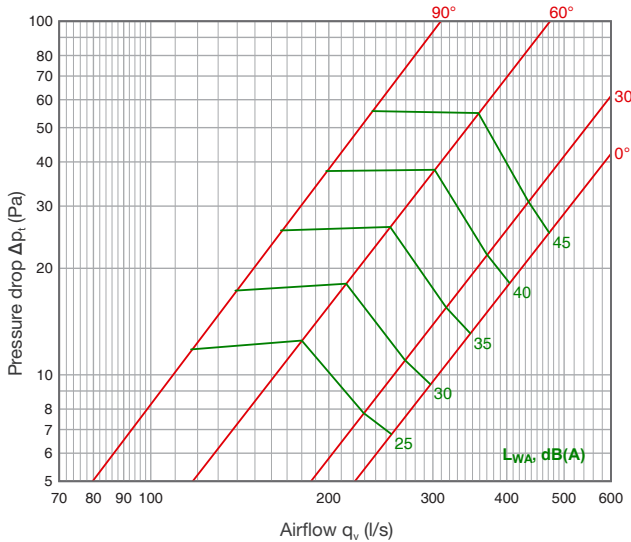

HCAH 2500x550

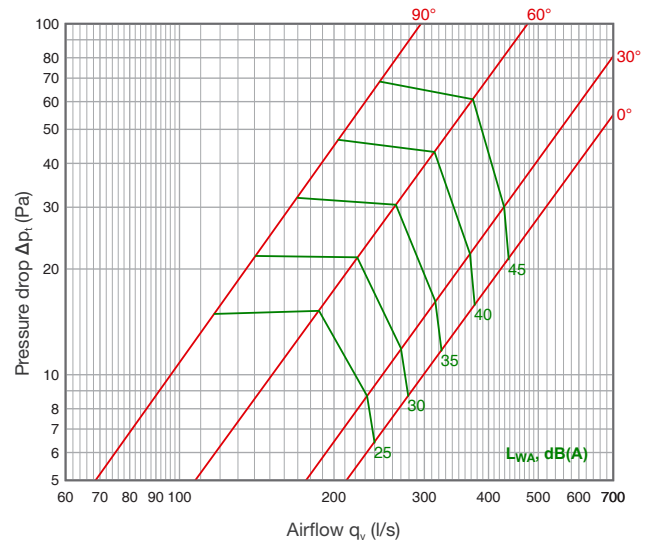

Acoustic data

$$L_w = L_{WA} + K_{okt}$$

Product	Front panel	Position	K-factor	Sound level correction factor K_{okt} (dB)							
				Mean frequency of octave band (Hz)							
				63	125	250	500	1k	2k	4k	8k
HCAH 1000x400	SPx0	0°	10,3	-2	-2	-3	-8	-3	-2	-13	-21
		90°	15,5	-4	0	7	3	-6	-13	-17	-20
	SPx3	60°	25,4	1	4	6	1	-1	-9	-16	-22
		30°	48,9	3	5	8	2	-2	-12	-19	-22
HCAH 1000x550	SPx0	0°	62,5	1	6	8	2	-3	-12	-20	-22
		90°	11,3	-2	-3	-3	-6	-2	-2	-14	-22
	SPx3	60°	15,4	-4	1	7	4	-7	-14	-17	-20
		30°	24,6	7	9	8	3	-5	-11	-17	-22
HCAH 1500x550	SPx0	0°	44,5	2	5	6	2	-2	-11	-18	-22
		90°	62,9	3	6	7	3	-2	-11	-19	-23
	SPx3	60°	13	-1	-2	-2	-3	0	-3	-16	-23
		30°	15,6	-4	1	7	4	-6	-14	-17	-21
HCAH 2500x550	SPx0	0°	25,3	5	8	8	3	-5	-12	-17	-22
		90°	52,5	2	6	7	2	-2	-12	-19	-23
	SPx3	60°	86,9	2	6	7	3	-3	-12	-21	-26
		30°									

Product	Front panel	Position	K-factor	Sound level correction factor K_{okt} (dB)							
				Mean frequency of octave band (Hz)							
				63	125	250	500	1k	2k	4k	8k
HCAH 2000x550	SPx0	0°	16,1	-1	-1	0	-3	0	-4	-14	-22
		90°	33,6	-2	3	7	3	-8	-15	-19	-22
	SPx3	60°	53,3	5	9	8	2	-4	-12	-18	-23
		30°	102	3	7	7	2	-3	-12	-19	-24
		0°	144	3	8	7	3	-3	-13	-21	-25
HCAH 2500x550	SPx0	0°	18,9	0	2	4	3	-2	-9	-18	-23
		90°	30,8	-1	3	6	4	-6	-13	-17	-22
	SPx3	60°	51,7	7	9	7	3	-5	-11	-18	-23
		30°	99,6	4	8	6	3	-2	-11	-20	-24
		0°	142	2	7	6	3	-2	-10	-20	-25

Product marking

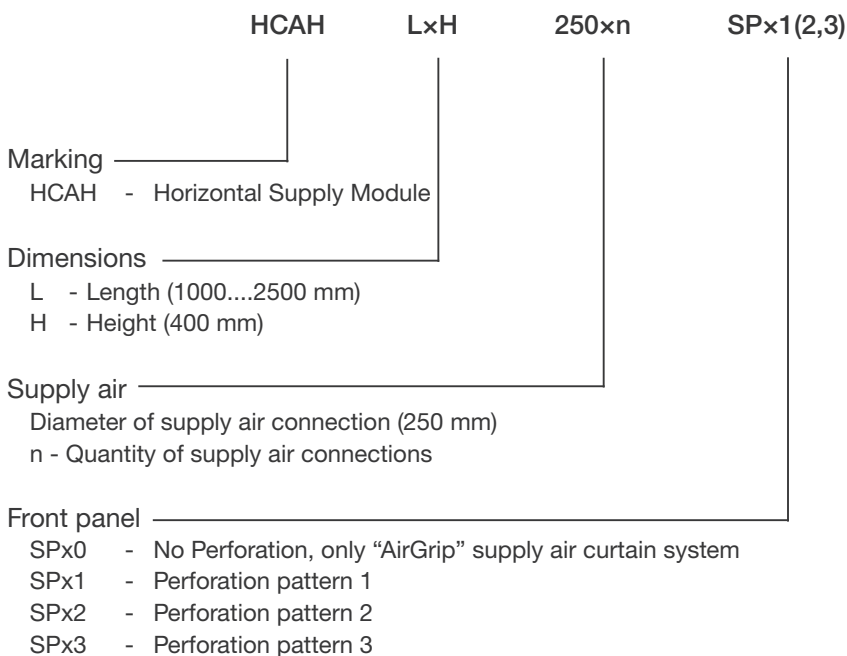

Example: HCAH 1500x400 250x1 SPx1

HCL LED Light Module

Professional kitchens require functional lighting to ensure that employees have a safe and effective work environment. ETS NORD professional kitchen canopies use the next generation of energy-efficient LED luminaries, which can save as much as 50% more energy compared to old technologies.

LED light fixtures are integrated into ceiling modules, protected by an aluminum and plastic glass casing. The size and number of light fixtures are determined by the size of the ventilation ceiling, to ensure there is enough light output for the entire workspace. Our integrated LED and DALI luminaries have two color temperature options - colder 4000K and warmer 3000K. It is also possible to choose between regular LED and DALI2 (dimnable) luminaries.

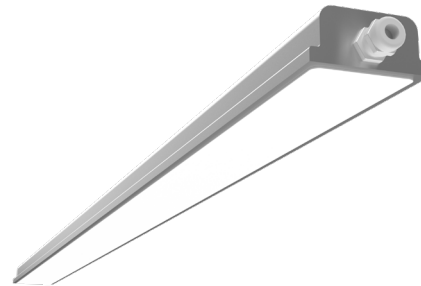
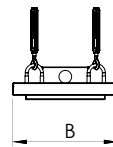
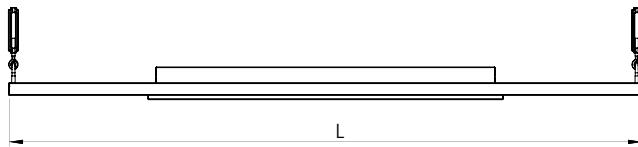

LED luminaries, IP66

Module length L, (mm)	Module width B, (mm)	Luminaries	Lighting length (mm)	Energy use (W)	Color temperature (K)	Color rendering index (Ra)	Flux (lm)
1000 ≤ L < 1300	250-500	LED-4000-600	600	17	4000	90	2907
1000 ≤ L < 1300	250-500	LED-3000-600	600	17	3000	90	2907
1400 ≤ L < 2500	250-500	LED-4000-1200	1200	34	4000	90	6498
1400 ≤ L < 2500	250-500	LED-3000-1200	1200	34	3000	90	6498

DALI2 LED luminaries, IP66

Module length L, (mm)	Module width B, (mm)	Luminaries	Lighting length (mm)	Energy use (W)	Color temperature (K)	Color rendering index (Ra)	Flux (lm)
1000 ≤ L < 1300	250-500	DALI2-4000-600	600	20	4000	90	3000
1000 ≤ L < 1300	250-500	DALI2-3000-600	600	20	3000	90	3000
1400 ≤ L < 2500	250-500	DALI2-4000-1200	1200	37	4000	90	6000
1400 ≤ L < 2500	250-500	DALI2-3000-1200	1200	37	3000	90	6000

Product marking

	HCL	LxB	LED/DALI
Marking	HCL - LED Light Module		
Dimensions	L - Length (1000-2500 mm) B - Width (250-500 mm)		
Lighting	LED-4000-600 - L=600, 17W, 4000K LED-4000-1200 - L=1200, 34W, 4000K LED-3000-600 - L=600, 17W, 3000K LED-3000-1200 - L=1200, 34W, 3000K DALI2-4000-600 - L=600, 20W, 4000K DALI2-4000-1200 - L=1200, 37W, 4000K DALI2-3000-600 - L=600, 20W, 3000K DALI2-3000-1200 - L=1200, 37W, 3000K		

Example:

HCL 1500x250 LED-4000-1200
 HCL 1000x250 DALI2-3000-600

HCF Ceiling Panel

HCF is a ceiling panel that fills in the areas without exhaust or supply modules.

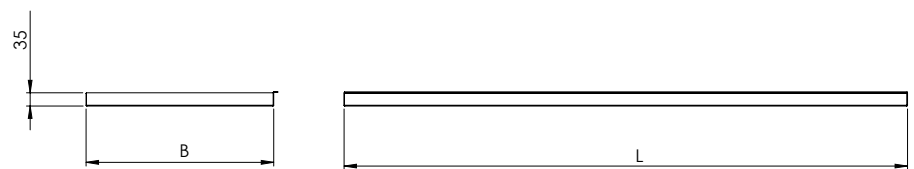
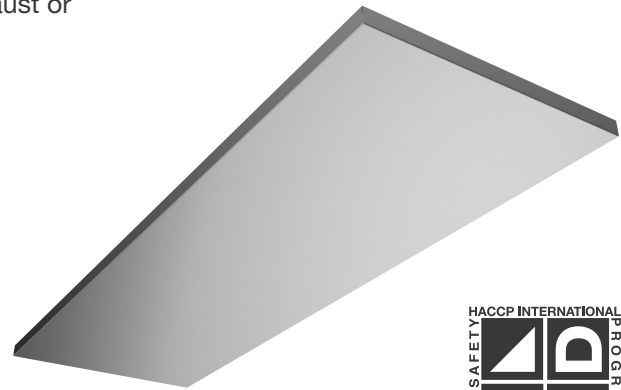

Product marking

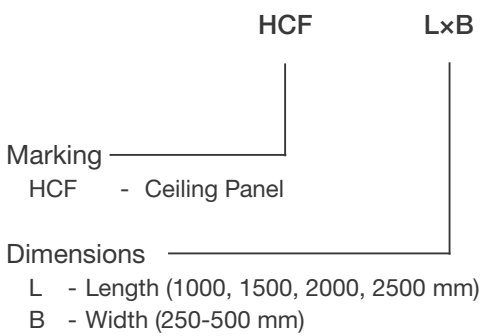

Example: HCF 1000x500

HCM Noise Absorbing Ceiling Panel

HCM is a noise absorbing ceiling panel that can be used instead of regular ceiling panel.

In standard tests measuring the absorption level, this solution has reached the highest level.

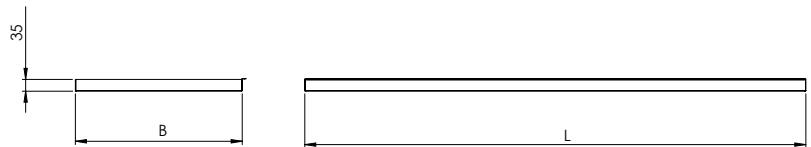
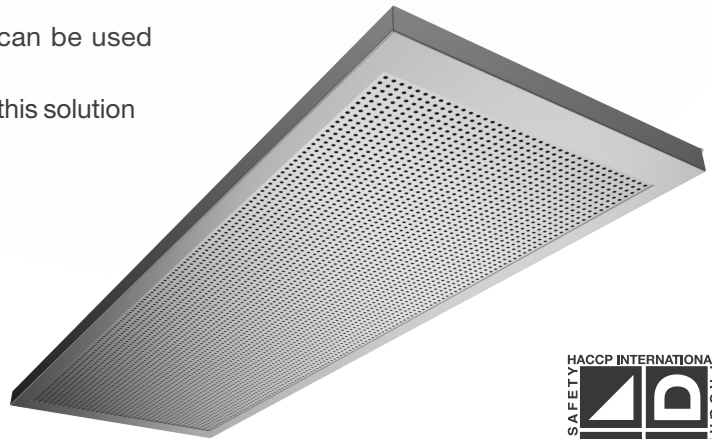

Acoustic performance

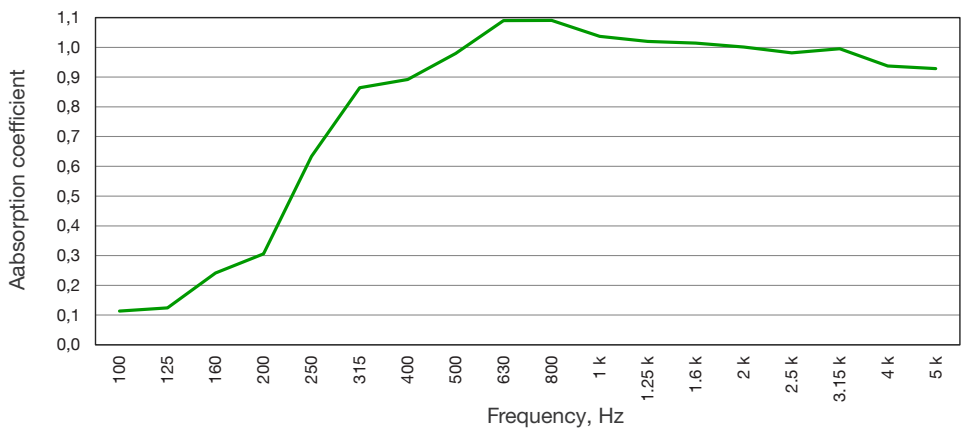

Product marking

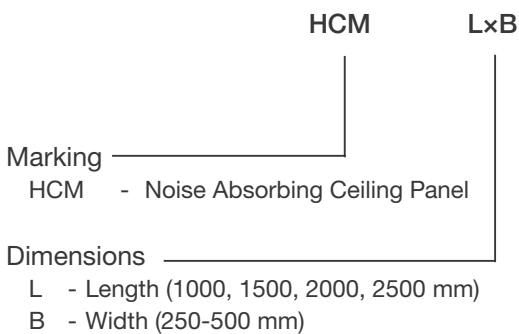

Example: HCM 1000x500

Exhaust and Supply Corner Elements

Corner connection elements enable to combine the chambers in a 90 degree angle for both inner and outer corner types. Solutions are compatible with HCE exhaust and HCH supply module.



HCAE
Inner Corner Exhaust

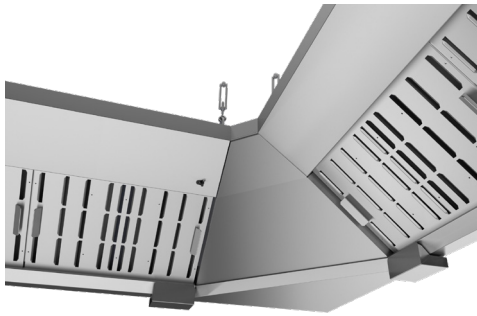

HCAS
Inner Corner Supply

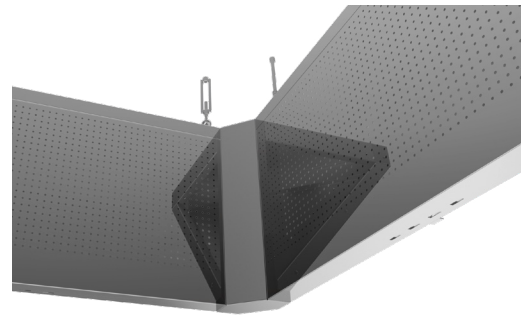

HCAV
Outer Corner Supply

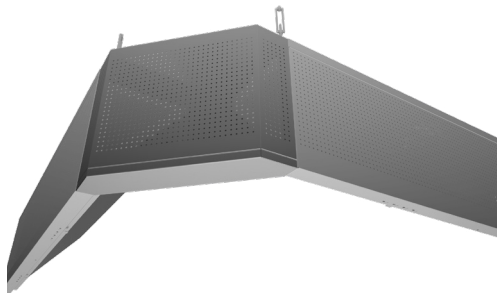

Product marking

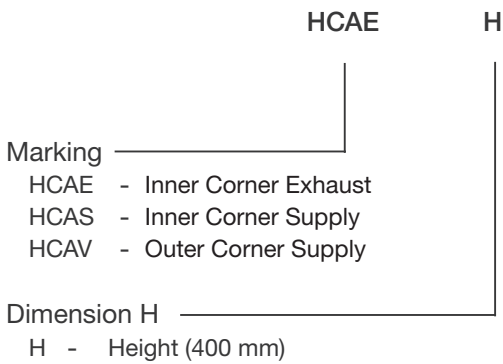

Example: HCAE 400

OZ/EOZ Ozonator







ETS NORDs OZ and EOZ are ozone cleaning systems that are intended to be used together with ETS NORD professional kitchen canopies or ventilation ceilings. The devices are designed for the exhaust air systems of professional kitchens with high requirements to minimize grease and odour. Using the Control Panel with versatile features (to be ordered separately), the use and monitoring of the integrated ozone cleaning system is effortless.

Function

Ozone (O_3) is a very effective oxidant, and when mixed into the kitchen's exhaust air breaks down grease and odour particles to water vapor, carbon dioxide and dry minerals.

Note! For best results with odour and grease reduction, the reaction time for ozone within a kitchen exhaust system should be at least two seconds. However, longer exposure can further improve results. This time should be considered during the design phase of the kitchen exhaust system.

Benefits obtained with ozone cleaning:

-  Effective grease reduction
-  Significantly improved fire safety
-  Enables the use of heat recovery
-  Effectively reduces odors
-  Effective at killing bacteria
-  Low maintenance costs



Without ozone cleaning system



With ozone cleaning system

OZ Ozone Unit

OZ Ozone Unit can be installed on top of the HC Ventilation Ceiling's exhaust chambers.



**NOTE! The Ozone Unit needs supply air to function!
In HC Ventilation Ceilings the Ozone Unit must not be installed if it doesn't have its own supply air duct installed.**

Technical data

Material: AISI 316L stainless steel
Working temperature: -25 to +40°C
Dimensions: 385x170x190 mm

The Ozone Unit is equipped with pressure switch and 3,15 A fuse. The pressure switch causes the module to start only when the required negative pressure is ensured.

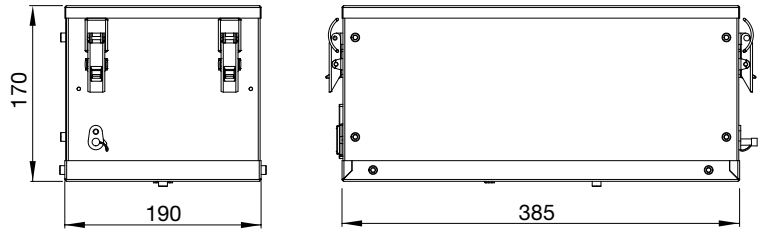

EOZ Ozone Generator

EOZ Ozone Generator can be installed to the HC Ventilation Ceiling's exhaust duct system. EOZ chassis contains one or more ozone modules and may be installed in any convenient location and orientation, as long as easy access for service is ensured.



Technical data

Material: AISI 316L stainless steel
Working temperature: -25 to +40°C

Model	Modules quantity	b (mm)	c (mm)	Ød (mm)	Weight (kg)	Voltage (V, Hz)	Max power (W)
EOZ-1	1	250	125	125	13	230/50	300
EOZ-2	2	450	225	160	20	230/50	600

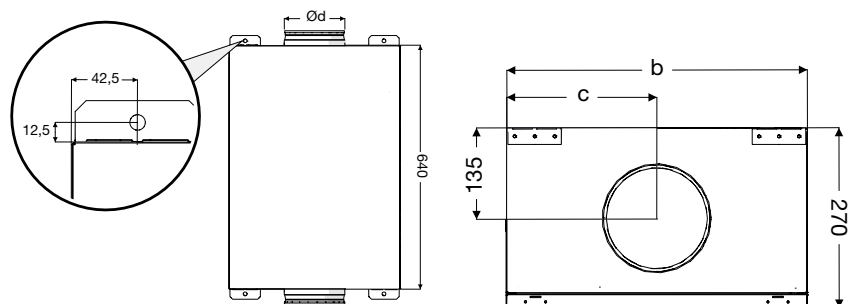

Control Panel

All Ozone Modules are managed by an intelligent central Control Panel. Only one Control Panel is needed per kitchen, regardless of the number of ozone generators installed. The Control Panel monitors the operation of each Ozone Module on the premises with an advanced control and reporting technology and will trigger an alarm in case of equipment failure or the need for maintenance. The Control Panel can be connected to either BACnet or Modbus-driven systems, enabling remote management via either the local network or Internet.

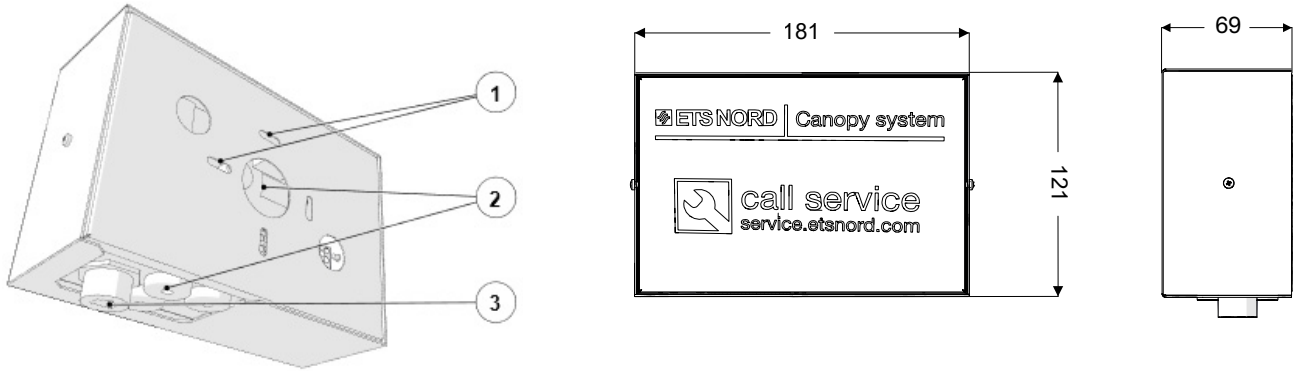

- 1 – Anchor points for wall mounts
- 2 – Data cable bushings
- 3 – RJ-45 connector

There are three cables that must be connected to the Control Panel:

- A Data cable (3x0,25 mm²) for communication between the Control Panel and EOZ unit;
- An I/O cable (5x0,5 mm²) for connection to the building automation;
- A LAN cable for accessing the Control Panel operations interface via the local area network or Internet.

Advantages:

- Compatibility with building automation
- Remote monitoring (IoT - Internet of Things)
- Data visualization and history
- Easy and safe to use

EtherNet/IP™



This symbol indicates that when the end-user wishes to discard the device, it must be taken to a proper waste station for recycling.

For further technical information and installation, please find detailed information from the ozone documentation on our website or contact your ETS NORD representative.

HFK Grease Filter

HFK is a high efficiency grease filter designed for use in ventilation hoods of commercial kitchens or other food production facilities. They are positioned in the hood exhaust plenum above cooking appliances (stoves, grills, etc.) and separate grease and other particles out from the exhaust air stream.

The ETS NORD HFK grease filter is protected by utility patent no. 01310.

- High efficiency captures 97% of 10 micron particles
- Functions well even with variable air volume systems
- Low pressure drop provides energy-efficient operation
- Flame resistance class A according to DIN 18869-5
- Easy to maintain
- Grease particle separation is measured according to VDI 2052 standard.

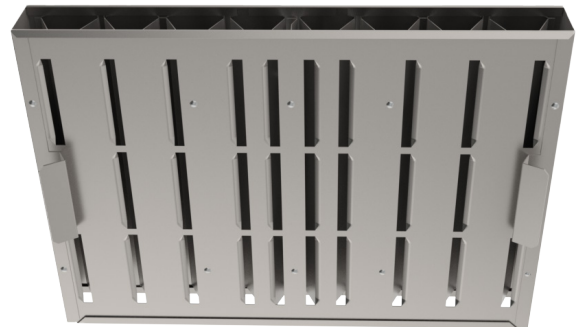

Material and design

HFK filters are manufactured from AISI 304 stainless steel. They are assembled with rivets to ensure their durability through many years of use in challenging kitchen environments.

Operation

The greasy effluent from cooking appliances is pulled through the openings in the front panel of the filter. Our patented double-triangular cross-section within the chamber causes a high speed centrifugal swirling of the air. The rapid change of trajectory of the grease particles causes them to collide with the filter surfaces, resulting in their effective separation from the air stream. The grease then drains from the filter down and into the grease collection channel of the hood. The filtered air continues on into the kitchen exhaust system through the top and bottom orifices of the filter.

The optimal operating conditions of the HFK Grease Filter are under a pressure drop from 12-48 Pa with an airflow through each filter from 70-130 l/s, ensuring an energy efficient operation.

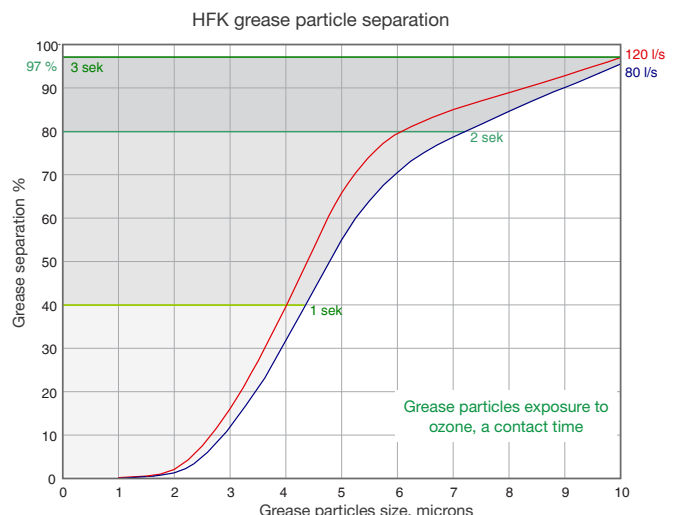
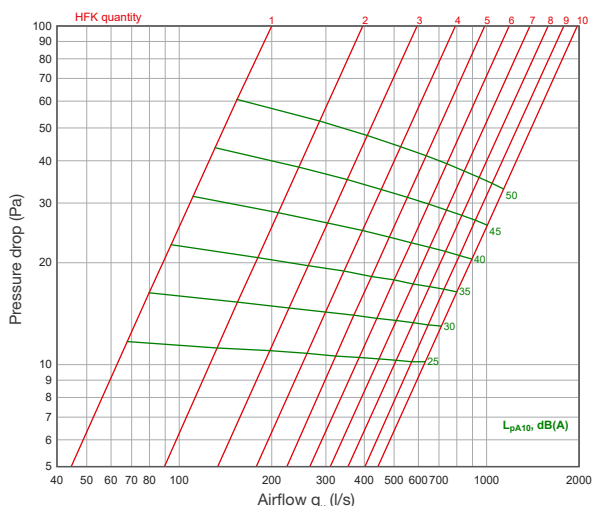

Sound attenuation of HFK

$$L_{w\text{okt}} = L_{pA} + K_{\text{okt}}$$

HFK	Sound level correction factor K_{okt} (dB)							
	Mean frequency of octave band (Hz)							
	63	125	250	500	1000	2000	4000	8000
K	4	3	0	1	0	-4	-15	-21

FET "Helping Hand" Filter Removal Tool

- With the ETS NORD "Helping Hand" filter tool, professional kitchen operators can safely and easily service their grease filters.
- Helping Hand allows grease filters to be removed and replaced without the cumbersome need to climb on or reach over kitchen equipment.
- The daily filter washing process is significantly simplified, thus ensuring its completion by the responsible staff.
- The tool's length is fully adjustable, thereby enhancing ergonomic comfort.





ETS NORD AS

Address: Peterburi tee 53
11415 Tallinn
Estonia

Phone: +372 680 7360
info@etsnord.ee
www.etsnord.ee

ETS NORD Finland

Address: Pakkasraitti 4
04360 Tuusula
Finland

Phone: +358 40 184 2842
info@etsnord.fi
www.etsnord.fi

ETS NORD Sweden

Address: Järsjögatan 7
692 35 Kumla
Sweden

Phone: +46 19 554 20 50

Address: Pinjegatan 5
213 63 Malmö
Sweden

Phone: +46 40 94 68 70

Address: Förrådsvägen 5
151 58 Södertälje
Sweden

Phone: +46 8 550 301 40

info@etsnord.se
www.etsnord.se

ETS NORD International

info@etsnord.com
www.etsnord.com

Let's move the air together!

